

Palm grip B3



The palm grip B3 has different equipment options for many requirements. It is compatible with our multi-axis controller or mounted on hydraulic drives. The palm grip has a highly flexible single wire (0,1 mm², 450 mm long). The mounting piece can be supplied with a tapped hole 12 mm (standard) or 10 mm.



Technical data

Operating temperature	-40°C to +60°C
Storage temperature	-50°C to +80°C
Degree of protection	IP65
Contact complement	1,5A 24 V DC13 (*1 0,1A 24 V DC13)

		<i>Example</i>							
		B3	-2D	W	K	SE	PA11	PA13	-X
Basic unit									
B3	Palm grip								
Digital actuating element									
D	Push button Colour: red, black, yellow, green, blue, grey								
D	Push button KDA21 *1 Colour: red, black, yellow, green, blue, white, orange								
W	Rocker switch T-0-T								
W	Rocker switch 0-T								
W	Rocker switch R-0-T								
W	Rocker switch R-0-R								
W	Rocker switch 0-R								
W	Rocker switch R-R								
K	Lever switch								
SR	Sliding switch								
ST	Sliding switch								
ZD	Push button with 2 steps								
A12	Push button Pos. 11-12								
A11	Thumbwheel T-0-T								
A11	Thumbwheel R-0-R L left, R right								
A13	Rotary grip T-0-T								
SE	Sensor button capacitive								
S	Sensor button capacitive without external control electronics (Consistent with V85 / VV85 and V25 with interface E3xx + E4xx + E5xx + E6xx)								
V	Vibration								



B3L -2D W K SE PA11R PA13 -X

Analog actuating element

PA11	Thumbwheel Potentiometer T375 2 x 5 kOhm with direction contacts
H11	Thumbwheel Hall-Potentiometer Output 0,5...2,5...4,5 V inverse dual L left, R right
PA12	Push button analog Pos. 11+12 Potentiometer T375 2 x 5 kOhm with direction contacts
H12	Push button analog Pos. 11+12 Hall-Potentiometer Output 0,5...2,5...4,5 V inverse dual
PA13	Rotary handle Potentiometer T375 2 x 5 kOhm with direction contacts
H13	Hall-Rotary handle Output 0,5...2,5...4,5 V inverse dual

Special model

X	Special / customer specified
---	------------------------------

Attachments

Z01	Bellow KMD 109	10300009
Z02	Bellow KMD 190	10300093
Z03	Rosette KBF 905 with 4 screws M5 x 15 necessary for bellow KMD 190	520990004

B3

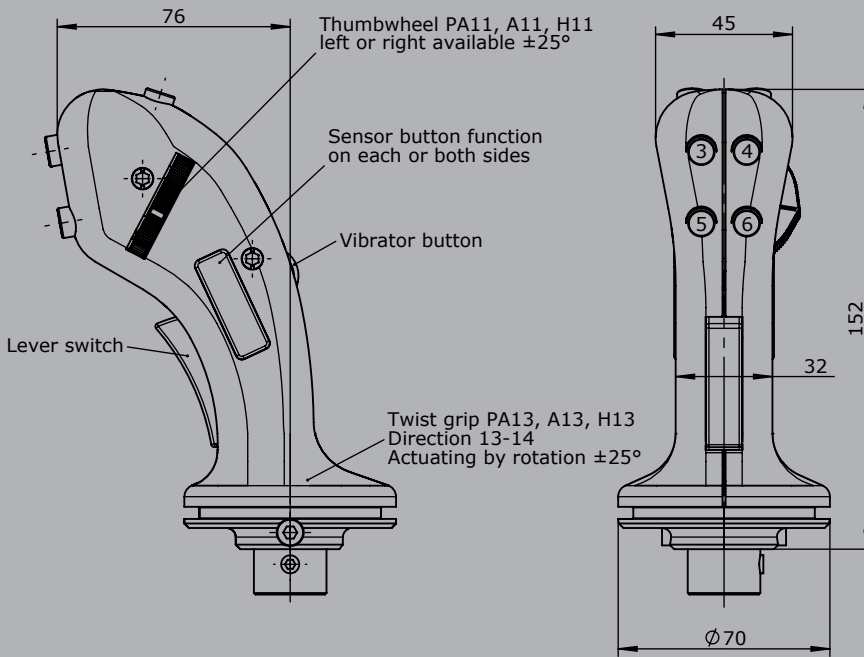

Edition:
Push button standard
installed Pos. 1,2

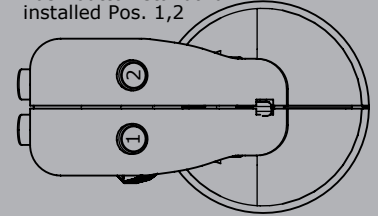

Edition:
Rocker switch
installed Pos. 7+8

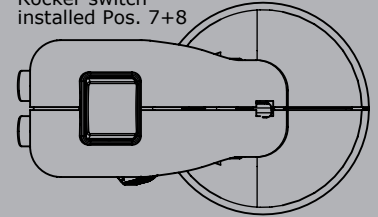

Edition:
Sliding switch
installed Pos. 13 + 14
Drive with potentiometer PA12 bzw.
Push button with 2 steps ZD
installed Pos. 11,12

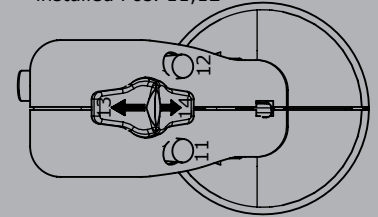

() = Installation right

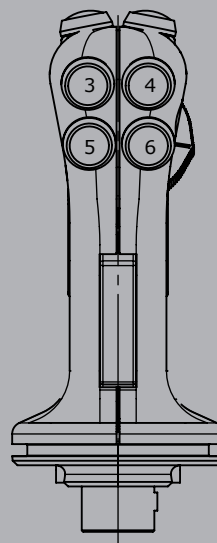
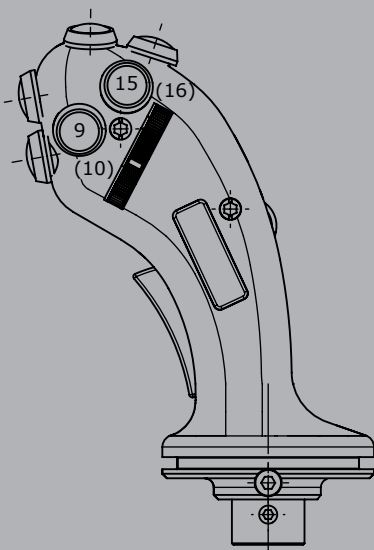

Edition:
Push button KDA 21
installed Pos. 1,2,7,8

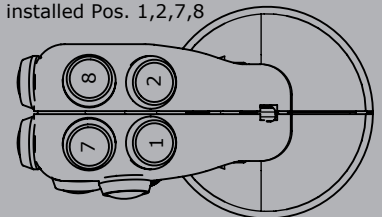

Edition:
Rocker switch
installed Pos. 7 + 8
Push button
installed Pos. 1,2

